

# Synchronization of Interconnected Systems With Applications to Biochemical Networks: An Input-Output Approach

Luca Scardovi, *Member, IEEE*, Murat Arcak, *Senior Member, IEEE*, and Eduardo D. Sontag, *Fellow, IEEE*

**Abstract**—This paper provides synchronization conditions for networks of nonlinear systems. The components of the network (referred to as “compartments” in this paper) are made up of an identical interconnection of subsystems, each represented as an operator in an extended  $L_2$  space and referred to as a “species.” The compartments are, in turn, coupled through a diffusion-like term among the respective species. The synchronization conditions are provided by combining the input-output properties of the subsystems with information about the structure of the network. The paper also explores results for state-space models, as well as biochemical applications. The work is motivated by cellular networks where signaling occurs both internally, through interactions of species, and externally, through intercellular signaling. The theory is illustrated by providing synchronization conditions for networks of Goodwin oscillators.

**Index Terms**—Graph theory, interconnected systems, input-output stability, nonlinear systems, synchronization.

## I. INTRODUCTION

THE analysis of synchronization phenomena in networks has become an important topic in systems and control theory, motivated by diverse applications in physics, biology, and engineering. Emerging results in this area show that, in addition to the individual dynamics of the components, the network structure plays an important role in determining conditions leading to synchronization [1]–[5].

In this paper, we study synchronization in networks of nonlinear systems, by making use of the input-output properties of the subsystems comprising the network. Motivated by cellular networks where signaling occurs both internally, through interactions of species, and externally, through intercellular signaling, we assume that each component of the network (referred

to as a “compartment” in the paper) itself consists of subsystems (referred to as “species”) represented as operators in the extended  $L_2$  space. The input to the operator includes the influence of other species within the compartment as well as a diffusion-like coupling term between identical species in different compartments.

A similar input-output approach was taken in [6]–[8] to study stability properties of individual compartments, rather than synchronization of compartments. These studies verify an appropriate *passivity* property [9], [10] for each species and form a “dissipativity matrix,” denoted here by  $E$ , that incorporates information about the passivity of the subsystems, the interconnection structure of the species, and the signs of the interconnection terms. To determine the stability of the network, [7], [8] check the *diagonal stability* of the dissipativity matrix, that is, the existence of a diagonal solution  $D > 0$  to the Lyapunov equation  $E^T D + DE < 0$ , similarly to classical work on large-scale systems by Vidyasagar and others, see [11]–[13].

In the special case of a *cyclic* interconnection structure with negative feedback, this diagonal stability test encompasses the classical *secant criterion* [14], [15] used frequently in mathematical biology. Following [6], [7], [16] investigated synchronization of cyclic feedback structures using an incremental variant of the passivity property. This reference assumes that only one of the species is subject to diffusion and modifies the secant criterion to become a synchronization condition.

With respect to previous work, the main contributions of the present paper are as follows: i) The results are obtained by using a purely input-output approach. This approach requires in principle minimal knowledge of the physical laws governing the systems, and is therefore particularly well-suited to applications displaying high uncertainty on parameters and structure, such as (molecular) biological systems. Results for systems with an “internal description”, i.e. in state space form, are derived as corollaries. ii) The individual species are required to satisfy a weaker condition with respect to the one assumed in [16]. iii) The interconnections among the subsystems composing each network are not limited to cyclic topologies, thus enlarging the class of systems for which synchronization can be proved. iv) The diffusive coupling can involve more than one species and its topology is not required to be balanced. v) The new formulation allows exogenous signals, and studies their effect on synchronization.

The paper is organized as follows. In Section II the notation used throughout the paper is summarized, and the model under study is introduced. In Section III the main results are presented, and the proofs can be found in Section IV. In Section V the

Manuscript received March 14, 2009; revised July 21, 2009, September 14, 2009. First published February 02, 2010; current version published June 09, 2010. This work was supported in part by ONR Grants N00014-02-1-0826 and N00014-04-1-0534, NSF Grant ECCS 0852750, AFOSR Grant FA 9550-09-1-0092, NSF Grants 0504557 and 0614371, NIH Grant 1R01GM086881, and AF Grant FA9550. Recommended by Associate Editor D. Braatz.

L. Scardovi is with the Department of Electrical Engineering and Information Technology, Technische Universität München (TUM), Munich 80333, Germany (e-mail: scardovi@tum.de).

M. Arcak is with the Department of Electrical Engineering and Computer Sciences, University of California, Berkeley, CA 94720 USA (e-mail: arcak@eecs.berkeley.edu).

E. D. Sontag is with the Department of Mathematics, Rutgers University, New Brunswick, NJ 08901 USA (e-mail: sontag@math.rutgers.edu).

Color versions of one or more of the figures in this paper are available online at <http://ieeexplore.ieee.org>.

Digital Object Identifier 10.1109/TAC.2010.2041974

operator property required to derive the synchronization condition is related to verifiable conditions for particular classes of systems described by ODE's; moreover the main results are extended to the case where the compartmental and the species couplings involve different variables. In Section VI, we show that the synchronization condition can be expressed in terms of algebraic inequalities, for particular classes of interconnection structures. Finally, in Section VII, we illustrate the proposed theory, deriving synchronization conditions for a network of Goodwin oscillators and convergence conditions for nonlinear state observers.

## II. PRELIMINARIES AND PROBLEM STATEMENT

We denote by  $L_{2e}$  the extended space of signals  $w : [0, \infty) \rightarrow \mathbb{R}$  which have the property that each restriction  $w_T = w|_{[0,T]}$  is in  $L_2(0, T)$ , for every  $T > 0$ . Given an element  $w \in L_{2e}$  and any fixed  $T > 0$ , we write  $\|w\|_T$  for the  $L_2$  norm of the restriction  $w_T$ , and given two functions  $v, w \in L_{2e}$  and any fixed  $T > 0$ , the inner product of  $v_T$  and  $w_T$  is denoted by  $\langle v, w \rangle_T$ . The same notation is used for vector functions.<sup>1</sup>

Consider  $n$  identical *compartments*, each composed of  $N$  subsystems that we refer to as *species*. The input-output behavior of species  $k$  in compartment  $j$  is described by

$$y_{k,j} = H_k v_{k,j}, \quad k = 1, \dots, N, \quad j = 1, \dots, n \quad (1)$$

where  $H_k$  is an operator to be further specified. The interconnections among species and compartments are given by

$$v_{k,j} = w_{k,j} + \sum_{i=1}^N \sigma_{k,i} y_{i,j} + \sum_{z=1}^n a_{j,z}^k (y_{k,z} - y_{k,j}) \quad (2)$$

$k = 1, \dots, N, j = 1, \dots, n$ , where the coefficients  $\sigma_{k,i} \in \mathbb{R}, k, i = 1, 2, \dots, N$ , represent the interconnection between different species, and are identical in each compartment. These coefficients are grouped into an  $N \times N$  matrix

$$\Sigma := [\sigma_{k,i}], \quad k, i = 1, 2, \dots, N \quad (3)$$

and the resulting interconnection is called *species coupling*.

The scalars  $a_{j,z}^k, k = 1, 2, \dots, N, j, z = 1, 2, \dots, n$  are non-negative and represent the interconnection among systems of the same species in different compartments. We will call this interconnection *compartmental coupling*. We assume that there are no self-loops, i.e.  $a_{j,j}^k = 0, k = 1, 2, \dots, N, j = 1, 2, \dots, n$ . Note that different species can possess different coupling structures (as implied by the superscript  $k$  in  $a_{j,z}^k$ ). The compartmental coupling is expressed in a diffusive-like form, as a function of the differences between species in the respective compartments, and not the species themselves. This is more general than true diffusion, which would correspond to the special case in which  $a_{j,z}^k = a_{z,j}^k$  for all  $k, j, z$ ; under this symmetry condition, the fluxes  $a_{j,z}^k (y_{k,z} - y_{k,j})$  and  $a_{z,j}^k (y_{k,j} - y_{k,z})$  (between the  $k$ th species in the  $j$ th and the  $z$ th compartments) would cancel each other out.

<sup>1</sup>We will denote by  $L_{2e}^m$  the extended space of  $m$  dimensional signals.

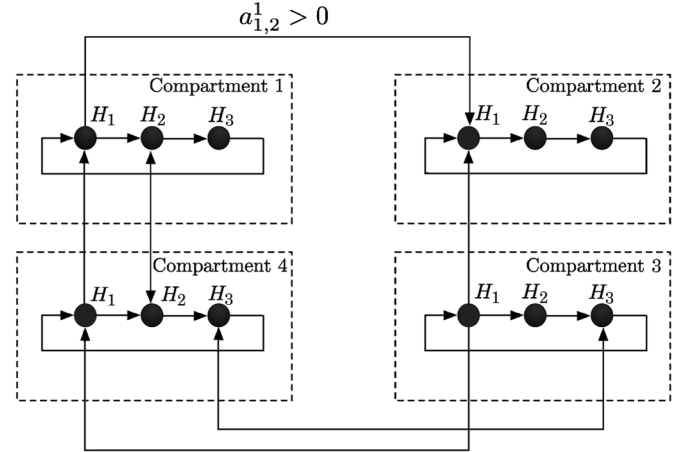

Fig. 1. Example of interconnection structure. Each compartment is composed by 3 subsystems (represented as nodes of a graph) each characterized by an operator  $H_k, k = 1, 2, 3$ . Two subsystems of the same species in different compartments are connected by an edge whenever the corresponding coefficient  $a_{j,z}^k$  is positive. In each compartment, different species are interconnected according to a directed graph where the output of a system characterized by the operator  $H_i$  enters as input of another system (characterized by an operator  $H_j$ ) weighted by the coefficient  $\sigma_{j,i}$ . In this example, the interconnections are cyclic ( $\sigma_{i,j} = 0$  unless  $i = j + 1 \bmod N$ ), but the theory allows arbitrary graphs. The compartments composing the network are assumed to be identical. For simplicity, no external inputs are shown in this figure.

Finally, the scalars  $w_{k,j}$  are external inputs that can model e.g.,  $L_{2e}$  disturbances acting on the systems. The resulting interconnected system can be represented as a graph as illustrated in Fig. 1.

We denote by  $Y_k = [y_{k,1}, \dots, y_{k,n}]^T, V_k = [v_{k,1}, \dots, v_{k,n}]^T$  and  $W_k = [w_{k,1}, \dots, w_{k,n}]^T$  the vectors of the outputs, inputs and external signals of systems of the same species  $k$ . Given a set of vectors  $Z_k, k = 1, 2, \dots, N$ , we indicate the stacked vector by  $Z := \text{col}(Z_1, \dots, Z_N)$ , e.g. we will indicate the stacked vector of outputs by  $Y = \text{col}(Y_1, \dots, Y_N)$ .

We then rewrite the feedback law (2) as

$$V_k(t) = W_k(t) + \sum_{i=1}^N \sigma_{ki} Y_i(t) - L_k Y_k(t), \quad k = 1, 2, \dots, N \quad (4)$$

where  $L_k, k = 1, \dots, N$ , are Laplacian matrices associated to the compartmental coupling

$$l_{i,j}^k = \begin{cases} \sum_{z=1}^n a_{i,z}^k, & i = j \\ -a_{i,j}^k, & i \neq j. \end{cases}$$

The connectivity properties of the corresponding graphs are related to the algebraic properties of the Laplacian matrices and, in particular, to the notion of *algebraic connectivity* extended to directed graphs in [17]:

*Definition 1:* For a directed graph with Laplacian matrix  $L_k$ , the *algebraic connectivity* is the real number defined as

$$\lambda_k := \min_{z \in \mathcal{P}} z^T L_k z$$

where  $\mathcal{P} = \{z \in \mathbb{R}^n : z \perp 1_n, \|z\| = 1\}$  and where  $1_n \triangleq [1, 1, \dots, 1]^T \in \mathbb{R}^n$ .

To characterize synchronization mathematically, we denote the average of the outputs of the  $n$  copies of the species  $k$  by

$$\bar{Y}_k := \frac{1}{n} \mathbf{1}_n^T Y_k$$

where  $\mathbf{1}_n \triangleq [1, 1, \dots, 1]^T \in \mathbb{R}^n$ ,  $k = 1, 2, \dots, N$ , and define

$$Y_k^\Delta := \text{col}(y_{k,1} - \bar{Y}_k, \dots, y_{k,n} - \bar{Y}_k). \quad (5)$$

Because  $Y_k^\Delta$  is equal to zero if and only if  $Y_k = \alpha_k \mathbf{1}_n$  for some  $\alpha_k \geq 0$ ,  $\|Y_k^\Delta\|_T$  measures the synchrony of the outputs of the species  $k$  in the time interval  $[0, T]$ . The same notation is used to define the vectors  $V_k^\Delta$  and  $W_k^\Delta$ .

We recall now an operator property that will be extensively used in the paper (the definitions are slightly adapted versions of those in [18], [19] and [10]).

*Definition 2:* Let  $H : L_{2e}^m \rightarrow L_{2e}^m$ . Then  $H$  is relaxed cocoercive if there exists some  $\gamma_c \in \mathbb{R}$  such that for every pair of inputs  $u, v \in L_{2e}^m$

$$\gamma_c \|Hu - Hv\|_T^2 \leq \langle Hu - Hv, u - v \rangle_T, \quad \forall T \geq 0. \quad (6)$$

If (6) holds with  $\gamma_c \geq 0$ , then  $H$  is called monotone. If (6) holds with  $\gamma_c > 0$ , then  $H$  is called cocoercive.

Cocoercivity implies monotonicity and monotonicity implies relaxed cocoercivity. We refer to the maximum possible  $\gamma_c$  with which (6) holds as the *cocoercivity gain*, and denote it as  $\gamma$ . The existence of  $\gamma$  follows because the set of  $\gamma_c$ 's that satisfy (6) is closed from above. In particular, we will call  $\gamma$ -relaxed cocoercive the operators with a cocoercivity gain  $\gamma \in \mathbb{R}$ . Notice that a  $\gamma$ -relaxed cocoercive operator with a strictly positive  $\gamma$  is a cocoercive operator while, in general, it is only relaxed-cocoercive (and also monotone when  $\gamma \geq 0$ ). Sometimes in the literature the terms relaxed cocoercive, monotone, and cocoercive are referred as incrementally output-feedback passive, incrementally passive and incrementally output-strictly passive respectively [3].

When there is no coupling between the compartments, i.e.  $L_k = 0$ ,  $k = 1, 2, \dots, N$ , the compartments are isolated and their stability depends on the species coupling. Stability with species coupling has been studied in [6] with an input-output approach, and in [7], [8] with a Lyapunov approach. Using the *output strict passivity* property of the operators  $H_k$

$$\eta_k \|H_k u\|_T^2 \leq \langle H_k u, u \rangle_T \quad (7)$$

and defining the *dissipativity matrix*<sup>2</sup>

$$E_\eta := \Sigma - \Gamma_\eta \quad (8)$$

where

$$\Gamma_\eta := \text{diag}(\eta_1, \eta_2, \dots, \eta_N), \quad \eta := \text{col}(\eta_1, \dots, \eta_N)$$

and where  $\Sigma$  is the interconnection matrix (3), [7], [8] prove stability of the interconnected system from the *diagonal stability*

<sup>2</sup>The matrix used in [7], [8] is slightly different than the one used here; we are adopting the equivalent formulation found in [20].

of the dissipative matrix  $E_\eta$ ; that is, from the existence of a diagonal matrix  $D > 0$  such that

$$E_\eta^T D + D E_\eta < 0. \quad (9)$$

As we will see in Theorem 1 below, the dissipativity matrix plays an important role also when studying the synchronization properties of the system (1), (2). The key differences of Theorem 1 from [7], [8] is that the output strict passivity property (7) is replaced with the incremental property in Definition 2, and the coefficients  $\gamma_k$  in  $E_\gamma$  are augmented with  $\lambda_k$  terms from Definition 1, which are due to diffusive coupling of the compartments.

### III. MAIN RESULTS

The following theorem relates the properties of the interconnections and the operators to the synchrony of the outputs in the closed-loop system. In particular we show that, if the operators describing the open-loop systems are  $\gamma$ -relaxed cocoercive and the interconnection matrices satisfy certain algebraic conditions, the closed loop system has the property that external inputs with a ‘‘high’’ level of synchrony (as implied by a small  $\|W^\Delta\|_T$ ) produce outputs with the same property (small  $\|Y^\Delta\|_T$ ).

*Theorem 1:* Consider the closed loop system defined by (1), (2). Suppose that the following assumptions are verified:

- 1) Each operator  $H_k$  is  $\gamma_k$ -relaxed cocoercive as in Definition 2,  $k = 1, 2, \dots, N$ .
- 2) For  $k = 1, \dots, N$ ,  $\tilde{\gamma}_k := \lambda_k + \gamma_k > 0$ , where  $\lambda_k$  is the algebraic connectivity in Definition 1 associated to the matrix  $L_k$  that describes the compartmental coupling of species  $k$ .
- 3) The dissipativity matrix  $E_{\tilde{\gamma}}$  defined as in (8) with  $\tilde{\gamma} = \text{col}(\tilde{\gamma}_1, \dots, \tilde{\gamma}_N)$ , is diagonally stable.

Then, for all  $w_{k,j}, y_{k,j}$ ,  $k = 1, 2, \dots, N$ ,  $j = 1, 2, \dots, n$  that satisfy (1) and (2) we have

$$\|Y^\Delta\|_T \leq \rho \|W^\Delta\|_T, \quad \forall T \geq 0$$

for some  $\rho > 0$ , and all  $W \in L_{2e}^{Nn}$ . Moreover, if  $W^\Delta \in L_{2e}^{Nn}$ , then also  $Y^\Delta \in L_{2e}^{Nn}$ , and we have  $\|Y^\Delta\| \leq \rho \|W^\Delta\|$ .  $\square$

From Theorem 1 we observe that the compartmental coupling increases the co-cocoercivity gain of a species whenever the algebraic connectivity is strictly positive. Since high values of cocoercivity gains tend to improve diagonal stability the compartmental coupling has a beneficial effect on synchronization. The algebraic connectivity is intimately related to topological properties of the underlying graph associated to the compartmental coupling (see Section V, Remark 2).

This result can be extended to analyze synchronization in systems described with a state space formalism (with arbitrary initial conditions). This extension takes the form of a Corollary of Theorem 1. Consider the systems

$$\begin{aligned} \dot{x}_{k,j} &= f_k(x_{k,j}, v_{k,j}) \\ y_{k,j} &= h_k(x_{k,j}) \quad k = 1, \dots, N, \quad j = 1, \dots, n \end{aligned} \quad (10)$$

where  $y_{k,j}, v_{k,j}$  are scalars and  $x_{k,j} \in \mathbb{R}^p$  and the initial conditions are arbitrary. We assume that  $f_k(\cdot, \cdot)$  are locally Lipschitz in the first argument and that  $h_k(\cdot)$  are continuous. Furthermore

we assume that the systems are  $L_2$ -well-posed, in the sense that for each  $v_{k,j} \in L_{2e}$  and each initial state there is a unique solution defined for all  $t > 0$  and the corresponding outputs  $y_{k,j}(t)$  are also in  $L_{2e}$ .

If we set the initial conditions to zero we can define the input-output operators  $H_k : L_{2e} \rightarrow L_{2e}$  by substituting any input  $v_{k,j} \in L_{2e}$  in (10), solving the differential equation, and substituting the resulting state-space trajectory in  $y_{k,j} = h_k(x_{k,j})$  in order to obtain the output function  $y_{k,j}$ . If we assume that the operators  $H_k$  are well defined and we define the input as in (4) then the results of Theorem 1 apply to the closed loop system.

The assumption that the initial state of the systems are set to zero is easy to dispose of, assuming appropriate reachability conditions. The following Corollary of Theorem 1 states that under the assumptions of Theorem 1 plus reachability and detectability conditions, if the external inputs are not present, the solutions of the closed-loop systems asymptotically synchronize. In particular we will assume that the closed-loop system (10) is zero-state reachable, i.e. that for any state  $x^*$  there exists an input belonging to  $L_2$  that drives the system from the zero state to  $x^*$  in finite time.

*Corollary 1:* Consider system (10) and assume that the nonlinear operators  $H_k$ ,  $k = 1, 2, \dots, N$ , associated to (10) with zero initial conditions are well defined. Consider the closed-loop system defined by (10) with inputs as in (2) but with no external inputs (i.e.,  $W = 0$ ) and suppose that the conditions in Theorem 1 are verified and that the closed loop system is zero-state reachable. Then for all outputs that satisfy the closed loop system equations we have that  $\forall k = 1, \dots, N, \forall i, j = 1, \dots, n, y_{k,i}(t) - y_{k,j}(t) \rightarrow 0$ , as  $t \rightarrow \infty$ .

In addition, if for all initial states and all inputs, any two state trajectories satisfy

$$\|y_{k,j} - y_{k,i}\| \rightarrow 0 \Rightarrow \|x_{k,j} - x_{k,i}\| \rightarrow 0$$

$k = 1, \dots, N, j, i = 1, \dots, n$ , as  $t \rightarrow \infty$ , then all bounded solutions synchronize and the synchronized solution converges to the limit set of the isolated system (i.e., the system where  $a_{k,j} = 0$  for every  $k, j$ ).  $\square$

*Remark 1:* To guarantee that the solutions of the closed-loop system are bounded, additional conditions on the isolated systems are required. One option is to demand that each isolated system is semipassive (as proposed in [4]).

#### IV. PROOF OF THE MAIN RESULT AND COROLLARY

We define the  $(n-1) \times n$  matrix

$$Q = \begin{bmatrix} -1 + (n-1)\nu & 1 - \nu & -\nu & \cdots & -\nu \\ -1 + (n-1)\nu & -\nu & 1 - \nu & \ddots & \vdots \\ \vdots & \vdots & \ddots & \ddots & -\nu \\ -1 + (n-1)\nu & -\nu & \cdots & -\nu & 1 - \nu \end{bmatrix}$$

where

$$\nu = \frac{n - \sqrt{n}}{n(n-1)}.$$

It follows that  $Q1_n = 0$ ,  $QQ^T = I_{n-1}$ , and:

$$Q^T Q = \begin{bmatrix} \frac{n-1}{n} & \frac{-1}{n} & \cdots & \frac{-1}{n} \\ \frac{-1}{n} & \frac{n-1}{n} & \ddots & \vdots \\ \vdots & \ddots & \ddots & \frac{-1}{n} \\ \frac{-1}{n} & \cdots & \frac{-1}{n} & \frac{n-1}{n} \end{bmatrix} = I_n - \frac{1}{n} 1_n 1_n^T. \quad (11)$$

By observing that

$$\tilde{Y}_k := QY_k$$

is equal to zero for every  $k = 1, \dots, n$  if and only if  $Y_k = \alpha_k 1_n$  for every  $k = 1, \dots, N$ , for some  $\alpha_k \in \mathfrak{R}$ , it is evident that also  $\|\tilde{Y}_k\|$  is a measure of synchrony for the outputs of the species (in different compartments) denoted by the index  $k$ . Moreover, since  $Q^T QY_k = Y_k^\Delta$  from (5) and (11),  $\tilde{Y}_k$  and  $Y_k^\Delta$  are related by  $Y_k^\Delta = Q^T \tilde{Y}_k$  and, thus

$$\|Y_k^\Delta\|_T^2 = \int_0^T \tilde{Y}_k^T Q Q^T \tilde{Y}_k dt = \|\tilde{Y}_k\|_T^2, \quad k = 1, 2, \dots, N. \quad (12)$$

In what follows we will use the same notation to measure input synchrony, i.e., we define  $\tilde{U}_k = QU_k$ ,  $\tilde{W}_k = QW_k$ ,  $\tilde{V}_k = QV_k$ . Before proving Theorem 1 we present a preliminary Lemma:

*Lemma 1:* Consider the open-loop systems (1). If the operators  $H_k$ ,  $k = 1, 2, \dots, N$  are  $\gamma_k$ -relaxed cocoercive then

$$\gamma_k \|\tilde{Y}_k\|_T^2 \leq \langle \tilde{Y}_k, \tilde{V}_k \rangle_T, \quad k = 1, \dots, N \quad (13)$$

for each  $T > 0$  and every  $V_k \in L_{2e}^n$ .  $\square$

*Proof:* Consider the scalar product

$$\langle \tilde{V}_k, \tilde{Y}_k \rangle_T \quad (14)$$

and define  $z_{k,j} = v_{k,j} - \gamma_k y_{k,j}$  for every  $k, j$ , that in vector form reads

$$Z_k = V_k - \gamma_k Y_k. \quad (15)$$

Define  $\tilde{Z}_k = QZ_k$ . By substituting (15) in (14) we obtain

$$\langle \tilde{V}_k, \tilde{Y}_k \rangle_T = \langle \tilde{Z}_k, \tilde{Y}_k \rangle_T + \gamma_k \langle \tilde{Y}_k, \tilde{Y}_k \rangle_T. \quad (16)$$

We first claim that the term  $\langle \tilde{Z}_k, \tilde{Y}_k \rangle_T$  is nonnegative. To show this, we use the  $\gamma_k$ -relaxed cocoercivity property of  $H_k$  and obtain

$$\begin{aligned} \langle z_{k,i} - z_{k,j}, y_{k,i} - y_{k,j} \rangle_T &= \langle v_{k,i} - v_{k,j}, y_{k,i} - y_{k,j} \rangle_T \\ &\quad - \gamma_k \langle y_{k,i} - y_{k,j}, y_{k,i} - y_{k,j} \rangle_T \\ &\geq 0 \end{aligned} \quad (17)$$

for  $i, j = 1, 2, \dots, n$ . By summing (17) over  $i, j = 1, 2, \dots, n$  and by dividing by a normalization constant we get

$$\frac{1}{2n} \sum_{i,j=1}^n \langle z_{k,i} - z_{k,j}, y_{k,i} - y_{k,j} \rangle_T = \langle Z_k, Y_k \rangle_T - n \langle \tilde{Z}_k, \tilde{Y}_k \rangle_T \geq 0.$$

It follows that:

$$\begin{aligned} \langle \tilde{Z}_k, \tilde{Y}_k \rangle_T &= \langle Z_k, Q^T Q Y_k \rangle_T = \langle Z_k, Y_k - \mathbf{1}_n \bar{Y}_k \rangle_T \\ &= \langle Z_k, Y_k \rangle_T - n \langle \bar{Z}_k, \bar{Y}_k \rangle_T \geq 0 \end{aligned} \quad (18)$$

which proves the claim. Finally, from (16) and (18) we conclude that

$$\langle \tilde{V}_k, \tilde{Y}_k \rangle_T = \langle \tilde{Z}_k, \tilde{Y}_k \rangle_T + \gamma_k \langle \tilde{Y}_k, \tilde{Y}_k \rangle_T \geq \gamma_k \|\tilde{Y}_k\|_T^2$$

which is the desired inequality (13). ■

We are now ready to prove Theorem 1.

*Proof of Theorem 1:* Consider the inputs

$$V_k(t) = U_k(t) - L_k Y_k(t) \quad (19)$$

where  $L_k$  are the Laplacian matrices representing the coupling between the compartments and the  $U_k(t)$  are for now thought as external inputs. From Lemma 1 and substituting (19) in (13) we get

$$\gamma_k \|\tilde{Y}_k\|_T^2 \leq \langle \tilde{Y}_k, \tilde{U}_k \rangle_T - \langle \tilde{Y}_k, Q L_k Y_k \rangle_T. \quad (20)$$

Next, we note that  $I_n - Q^T Q = (1/n) \mathbf{1}_n \mathbf{1}_n^T$  is a projection matrix onto the span of  $\mathbf{1}_n$ . Because  $L_k \mathbf{1}_n = 0$ , it follows that  $L_k (I_n - Q^T Q) Y_k = 0$  and, thus

$$L_k Y_k = L_k Q^T Q Y_k = L_k Q^T \tilde{Y}_k. \quad (21)$$

By using (21) as well as the fact that

$$Y_k^T Q^T Q L^T Q^T Q Y_k = Y_k^T Q^T Q L Q^T Q Y_k$$

(because this expression is a scalar), we observe that

$$\begin{aligned} \langle \tilde{Y}_k, Q L_k Y_k \rangle_T &= \frac{1}{2} \int_0^T \tilde{Y}_k^T(t) Q (L_k + L_k^T) Q^T \tilde{Y}_k(t) dt \\ &\geq \lambda_k \int_0^T \tilde{Y}_k^T(t) \tilde{Y}_k(t) dt = \lambda_k \|\tilde{Y}_k\|_T^2 \end{aligned} \quad (22)$$

where  $\lambda_k$  are the smallest eigenvalues of the symmetric part of the “reduced Laplacian matrices”, i.e., of the matrices  $(1/2)Q(L_k + L_k^T)Q^T$ . By using the properties of the matrix  $Q$  it is straightforward to check that  $\lambda_k$  is the algebraic connectivity as defined in Definition 1. Combining (20) and (22) we obtain

$$\gamma_k \|\tilde{Y}_k\|_T^2 \leq \langle \tilde{Y}_k, \tilde{U}_k \rangle_T - \lambda_k \|\tilde{Y}_k\|_T^2.$$

From Assumption 2 we have that  $\lambda_k > -\gamma_k$  for  $k = 1, 2, \dots, n$ . We conclude that

$$\|\tilde{Y}_k\|_T^2 \leq \frac{1}{\tilde{\gamma}_k} \langle \tilde{Y}_k, \tilde{U}_k \rangle_T, \quad k = 1, 2, \dots, N \quad (23)$$

where  $\tilde{\gamma}_k = \gamma_k + \lambda_k$ . Now, we apply the feedback

$$U_k = W_k + \sum_{j=1}^N \sigma_{kj} Y_j, \quad k = 1, 2, \dots, N \quad (24)$$

to the resulting system, where  $\sum_{j=1}^N \sigma_{kj} Y_j$  represents the interconnection between the different species. By defining  $U = \text{col}(U_1, \dots, U_N)$  (we apply this convention in general to denote vectors stackings), we rewrite (24) as

$$U = W + (\Sigma \otimes I_n) Y.$$

We define

$$E_{\tilde{\gamma}} \triangleq \Sigma - \Gamma_{\tilde{\gamma}}$$

where

$$\Gamma_{\tilde{\gamma}} \triangleq \text{diag}(\tilde{\gamma}_1, \dots, \tilde{\gamma}_N).$$

From Assumption 3 the matrix  $E_{\tilde{\gamma}}$  is diagonally stable i.e. there exist positive constants  $d_i$ ,  $i = 1, \dots, N$  such that

$$D E_{\tilde{\gamma}} + E_{\tilde{\gamma}}^T D < 0 \quad (25)$$

and  $D = \text{diag}(d_1, \dots, d_N)$ . Choose  $\alpha > 0$  such that  $D E_{\tilde{\gamma}} + E_{\tilde{\gamma}}^T D < -2\alpha I_N$  and observe that

$$\begin{aligned} \langle D z, E_{\tilde{\gamma}} z \rangle_T &= \frac{1}{2} \int_0^T z^T(t) (D E_{\tilde{\gamma}} + E_{\tilde{\gamma}}^T D) z(t) dt \\ &\leq -\alpha \int_0^T z^T(t) z(t) dt = -\alpha \|z\|_T^2. \end{aligned}$$

From (23) we can write  $\langle d_k \tilde{Y}_k, \tilde{U}_k - \tilde{\gamma}_k \tilde{Y}_k \rangle_T \geq 0$ , for  $k = 1, 2, \dots, N$ , and therefore

$$\left\langle (D \otimes I_{n-1}) \tilde{Y}, \tilde{U} - (\Gamma_{\tilde{\gamma}} \otimes I_{n-1}) \tilde{Y} \right\rangle_T \geq 0$$

where  $\tilde{U} = \text{col}(\tilde{U}_1, \dots, \tilde{U}_N)$  and  $\tilde{Y} = \text{col}(\tilde{Y}_1, \dots, \tilde{Y}_N)$ . Substituting  $\tilde{U} = \tilde{W} + (\Sigma \otimes I_{n-1}) \tilde{Y}$ , where  $\tilde{W} = \text{col}(\tilde{W}_1, \dots, \tilde{W}_N)$ , we obtain

$$\left\langle (D \otimes I_{n-1}) \tilde{Y}, \tilde{W} + (E_{\tilde{\gamma}} \otimes I_{n-1}) \tilde{Y} \right\rangle_T \geq 0$$

and using the Cauchy–Schwartz inequality we write

$$\begin{aligned} \beta \|\tilde{W}\|_T \|\tilde{Y}\|_T &\geq \left\langle (D \otimes I_n) \tilde{Y}, \tilde{W} \right\rangle_T \\ &\geq - \left\langle (D \otimes I_n) \tilde{Y}, (E_{\tilde{\gamma}} \otimes I_n) \tilde{Y} \right\rangle_T \\ &\geq \alpha \|\tilde{Y}\|_T^2 \end{aligned}$$

for some  $\beta > 0$ . We conclude that

$$\|\tilde{Y}\|_T \leq \rho \|\tilde{W}\|_T, \quad \forall T \geq 0$$

for any  $W \in L_{2e}^{Nn}$ , where  $\rho = \beta/\alpha$ . As a direct consequence, if  $W \in L_2^{Nn}$  then  $\|\tilde{Y}\| \leq \rho \|\tilde{W}\|$ . We conclude by observing that  $\|\tilde{Y}_k\|_T = \|Y_k^\Delta\|_T$  and  $\|\tilde{W}_k\|_T = \|W_k^\Delta\|_T$  for every  $T \geq 0$  and  $k = 1, 2, \dots, N$ . ■

To prove Corollary 1 we follow an argument similar to the one used in [20] to prove stability of interconnected systems.

*Proof of Corollary 1:* Consider system (10) where the initial conditions  $x_{k,j}(0) = x_{k,j}^0$  are arbitrary, the inputs are

$$v_{k,j} = \sum_{i=1}^N \sigma_{k,i} y_{i,j} + \sum_{z=1}^n a_{j,z}^k (y_{k,z} - y_{k,j}) \quad (26)$$

for  $k = 1, \dots, N$ ,  $j = 1, \dots, n$ , and let  $x_{k,j}$  be the solutions of the closed loop system. Consider now system (10) with initial conditions  $z_{k,j}(0) = 0$  and inputs  $v_{k,j} + w_{k,j}$ . From zero-state reachability, there exist inputs  $\hat{w}_{k,j} : [0, T] \rightarrow \mathbb{R}$  such that the solutions at time  $T$  reaches the states  $x_{k,j}^0$ , i.e.  $z_{k,j}(T) = x_{k,j}^0$  for every  $k, j$ . Consider now the input

$$w_{k,j}(t) = \begin{cases} \hat{w}_{k,j} & t \in [0, T] \\ 0 & t > T \end{cases} \quad (27)$$

and let  $z_{k,j}(\cdot)$  be the solution with initial state  $z_{k,j}(0) = 0$  and input  $w_{k,j}(t)$  defined in (27). From causality we observe that  $z_{k,j}(T) = x_{k,j}(0)$  and therefore  $z_{k,j}(t+T) = x_{k,j}(t)$ ,  $t > T$ , and therefore studying the steady state behavior of  $z_{k,j}(\cdot)$  is equivalent to studying the steady state behavior of  $x_{k,j}(\cdot)$ . Consider the outputs  $s_{k,j}(\cdot)$  associated to the solutions  $z_{k,j}(\cdot)$  (with zero initial conditions and inputs  $w_{k,j}$ ). From Theorem 1 we know that  $\|S^\Delta\| \leq \rho \|W^\Delta\|$ . Since each input  $w_{k,j}$  is in  $L_2$ ,  $W^\Delta$  is in  $L_2^{n \times N}$  and we have that  $S^\Delta$  is in  $L_2^{n \times N}$  as well. Since the solutions  $z_{k,j}$  are bounded, from continuity of  $h_k(\cdot)$  we conclude that  $S$  and therefore  $S^\Delta$  is absolutely continuous (see e.g., [21]). From Barbalat's Lemma we conclude that  $S^\Delta \rightarrow 0$  for  $t \rightarrow \infty$  that implies that also  $Y^\Delta \rightarrow 0$  for  $t \rightarrow \infty$ . This proves output synchronization. State synchronization directly follows from the additional property that for all initial states and all inputs, given two state trajectories we have that

$$\|y_{k,j} - y_{k,i}\| \rightarrow 0 \Rightarrow \|x_{k,j} - x_{k,i}\| \rightarrow 0 \quad (28)$$

for  $k = 1, \dots, N$ ,  $j, i = 1, \dots, n$ , as  $t \rightarrow \infty$ . All the solutions that exist for all  $t \geq 0$  converge to the set where for every  $k = 1, \dots, N$ , and  $i, j = 1, \dots, n$ ,  $x_{k,i}(t) = x_{k,j}(t)$ , as  $t \rightarrow \infty$ . Since  $L_k 1_n = 0$  for every  $k = 1, \dots, N$ , for all bounded network solutions, the synchronized solution converges to the limit set of the isolated system (i.e. the system where the compartments are uncoupled). ■

## V. DISCUSSION AND EXTENSIONS

### A. Conditions for Relaxed Cocoercivity

The results presented require that the operators describing the input-output relation of the isolated systems are relaxed cocoercive. This condition must in general be checked case by case. Therefore, it is of interest to provide verifiable conditions, for particular classes of systems described by ODE's, that imply relaxed cocoercivity of the correspondent input-output operator.

Consider a one-dimensional system of the following form:

$$\begin{aligned} \dot{x} &= -f(x) + u \\ y &= x \end{aligned} \quad (29)$$

with zero initial conditions. Suppose that  $f$  is a function such that for every  $\sigma_1, \sigma_2 \in \mathbb{R}$

$$(\sigma_1 - \sigma_2)(f(\sigma_1) - f(\sigma_2)) \geq \gamma(\sigma_1 - \sigma_2)^2, \quad \gamma \in \mathbb{R}. \quad (30)$$

The study of conditions like (30) can be traced back to [22], [23]. Note that (30) is equivalent to require that system (29) is convergent when  $u = 0$  (see e.g., [24]). Sometimes, in the literature, condition (30) is named *QUAD condition* (see e.g., [25]–[27]). We now prove that the associated input-output operator from  $u$  to  $y$  is  $\gamma$ -relaxed cocoercive. Fix the initial condition to zero. Consider two input functions  $u_1$  and  $u_2$  belonging to  $L_{2e}$  and the corresponding outputs  $x_1$  and  $x_2$  (belonging to  $L_{2e}$  as well). Then

$$\frac{1}{2} \frac{d}{dt} (x_2 - x_1)^2 = (f(x_1) - f(x_2) + u_2 - u_1)(x_2 - x_1).$$

Since (30) holds, we conclude that

$$\frac{1}{2} \frac{d}{dt} (x_2 - x_1)^2 \leq -\gamma(x_2 - x_1)^2 + (u_2 - u_1)(x_2 - x_1).$$

Integrating both sides and assuming zero initial condition we finally obtain

$$0 \leq \frac{1}{2} (x_2(T) - x_1(T))^2 \leq -\gamma \|x_2 - x_1\|_T^2 + \langle u_2 - u_1, x_2 - x_1 \rangle_T$$

where the norm and the inner product are taken in the  $L_{2e}$  spaces, showing that the associated input-output operator is  $\gamma$ -relaxed cocoercive. This result particularizes to linear time invariant systems and, e.g., for the system  $\dot{x} = -ax + bu$ ,  $y = x$ , we obtain  $\gamma = a/b$ .

We conclude this section by remarking that Definition 2 particularizes to the special case in which the operator  $H$  is a nonlinear function  $y = h(x)$ . Moreover it is immediate to show that a monotone increasing and Lipschitz continuous static nonlinearity  $h(\cdot)$ , with Lipschitz constant  $(1/\xi) > 0$ , is a  $\xi$ -relaxed cocoercive operator (with positive  $\xi$ ).

### B. State Coupling Versus Output Coupling

The present work is motivated by synchronization in models of biochemical networks where the compartmental coupling represents the diffusion of reagent concentrations (states of the systems) through the compartments. The results presented in Section III assume that the species diffuse through the outputs that, in general, could be nonlinear functions of the species concentrations. In other words the compartmental and species couplings involve the same variables and this could be non realistic in the modeling of biological systems. In this section we generalize the results of the previous sections to handle this situation.

Consider the system

$$\begin{aligned} \dot{x}_{k,j} &= f_k(x_{k,j}, v_{k,j}) \\ y_{k,j} &= h_k(x_{k,j}), \quad k = 1, \dots, N, \quad j = 1, \dots, n \end{aligned} \quad (31)$$

where

$$v_{k,j} = w_{k,j} + \sum_{i=1}^N \sigma_{k,i} y_{i,j} + \sum_{z=1}^n a_{j,z}^k (x_{k,z} - x_{k,j})$$

$k = 1, \dots, N$ ,  $j = 1, \dots, n$ , that corresponds, in vector notation, to

$$V_k(t) = W_k(t) + \sum_{j=1}^n \sigma_{k,j} Y_j(t) - L_k X_k(t), \quad k = 1, 2, \dots, N. \quad (32)$$

Suppose that the solutions of (31) are defined for every input in  $L_{2e}$ , and that the respective output is in  $L_{2e}$  as well. We fix the initial conditions to zero and we define the nonlinear operators  $H_k$  associated to (31). Suppose that each operator  $H_k$  can be factorized as  $H_k = T_k G_k$  where  $T_k : v_{k,j} \rightarrow x_{k,j}$  is a nonlinear operator and  $G_k : x_{k,j} \rightarrow y_{k,j}$  is a static nonlinearity associated to the functions  $h_k(\cdot)$  from the real line to itself.

Suppose that the operators  $H_k$  and  $G_k$  are  $\gamma_k$ -relaxed cocoercive and  $\xi_k$ -relaxed cocoercive respectively. Consider now the closed loop system. We follow the same lines of the proof of Theorem 1 exploiting the cocoercivity of the functions  $h_k(\cdot)$  (associated to the operator  $G_k$ ). Consider the inputs

$$V_k(t) = U_k(t) - L_k X_k(t)$$

where  $U_k(t)$  are (for now) external inputs. Since  $H_k$  are  $\gamma_k$ -relaxed cocoercive, from Lemma 1, we get

$$\gamma_k \|\tilde{Y}_k\|_T^2 \leq \langle \tilde{Y}_k, \tilde{U}_k \rangle_T - \langle \tilde{Y}_k, Q L_k X_k \rangle_T, \quad k = 1, 2, \dots, N. \quad (33)$$

Next we observe that

$$\langle \tilde{Y}_k, Q L_k X_k \rangle_T = \int_0^T \tilde{Y}_k^T(t) Q L_k Q^T \tilde{X}_k(t) dt. \quad (34)$$

Let's fix  $k$  and define  $s = h_k(\sigma)$  and  $z(s) = \sigma - \xi_k s$ . We observe that  $z(s)$  is monotone increasing, in fact for every  $s_1, s_2 \in \mathbb{R}$

$$(s_1 - s_2)(z_1 - z_2) = (s_1 - s_2)(\sigma_1 - \sigma_2 - \xi_k(s_1 - s_2)) \geq 0$$

where the last inequality follows from the fact that  $h_k(\cdot)$  is  $\xi_k$ -relaxed cocoercive. By defining  $Z_k(Y_k) = \text{col}(z_k(y_{k,1}), \dots, z_k(y_{k,n}))$ , we use the identity  $X_k = \xi_k Y_k + Z_k$  to rewrite the right side of (34) as

$$\begin{aligned} & \frac{\xi_k}{2} \int_0^T \tilde{Y}_k^T(t) Q (L_k + L_k^T) Q^T \tilde{Y}_k(t) dt \\ & + \int_0^T Y_k^T Q^T Q L_k Q^T Q Z_k(Y_k) dt. \end{aligned}$$

Suppose that  $1_n^T L_k = 0$  then  $Y_k^T Q^T Q L_k Q^T Q Z_k(Y_k) = Y_k^T L_k Z_k(Y_k)$ . Since  $L_k$  are doubly hyperdominant and  $z_k(\cdot)$

are monotone increasing functions, from Theorem 3.7 in [18] we obtain

$$\int_0^T Y_k^T L_k Z_k dt \geq 0.$$

We conclude that

$$\langle \tilde{Y}_k, Q L_k X_k \rangle_T \geq \xi_k \lambda_k \int_0^T \tilde{Y}_k^T(t) \tilde{Y}_k(t) dt = \xi_k \lambda_k \|\tilde{Y}_k\|_T^2. \quad (35)$$

Combining (33) and (35) we obtain

$$\gamma_k \|\tilde{Y}_k\|_T^2 \leq \langle \tilde{Y}_k, \tilde{U}_k \rangle_T - \xi_k \lambda_k \|\tilde{Y}_k\|_T^2.$$

Therefore, if  $\xi_k \lambda_k > -\gamma_k$  for  $k = 1, 2, \dots, n$ , we conclude that

$$\|\tilde{Y}_k\|_T^2 \leq \frac{1}{\tilde{\gamma}_k} \langle \tilde{Y}_k, \tilde{U}_k \rangle_T, \quad k = 1, 2, \dots, N$$

where  $\tilde{\gamma}_k = \gamma_k + \xi_k \lambda_k$ .

The rest of the the derivation follows the same lines of the proof of Theorem 1 where  $\tilde{\gamma}_k = \lambda_k + \gamma_k$  are redefined by  $\tilde{\gamma}_k = \gamma_k + \xi_k \lambda_k$ . This leads to the following result.

**Theorem 2:** Consider the closed loop system defined by (31) and (32) with zero initial conditions. Assume that the input-output operators  $H_k, k = 1, 2, \dots, N$  associated to (31) are well-defined and suppose that the following assumptions are verified:

- 1) The operators  $H_k$  and the functions  $h_k(\cdot)$  are, respectively,  $\gamma_k$ -relaxed cocoercive and  $\xi_k$ -relaxed cocoercive for  $k = 1, 2, \dots, N$ .
- 2) The Laplacian matrices satisfy the condition  $1_n^T L_k = 0$  and for  $k = 1, \dots, N$ ,  $\tilde{\gamma}_k = \gamma_k + \xi_k \lambda_k > 0$ , where  $\lambda_k$  is the algebraic connectivity associated to the compartmental coupling.
- 3) The matrix  $E_{\tilde{\gamma}}$ , where  $\tilde{\gamma} = \text{col}(\tilde{\gamma}_1, \dots, \tilde{\gamma}_N)$ , is diagonally stable.

Then

$$\|Y^\Delta\|_T \leq \mu \|W^\Delta\|_T, \quad \forall T \geq 0$$

for some  $\mu > 0$  and  $W \in L_{2e}^{Nn}$ . Moreover, if  $W^\Delta \in L_2^{Nn}$ , we have  $\|Y^\Delta\| \leq \mu \|W^\Delta\|$ .

Furthermore, if the closed loop systems are zero-state reachable, the closed loop system (31) and (32) with no external inputs ( $W = 0$ ) and arbitrary initial conditions has the property that the outputs of the compartments synchronize, i.e.  $\forall k = 1, \dots, N, \forall i, j = 1, \dots, n, y_{k,i}(t) = y_{k,j}(t)$ , as  $t \rightarrow \infty$ . In addition, if for all initial states and all inputs any two state trajectories satisfy

$$\|y_{k,j} - y_{k,i}\| \rightarrow 0 \Rightarrow \|x_{k,j} - x_{k,i}\| \rightarrow 0$$

$k = 1, \dots, N, j, i = 1, \dots, n$ , as  $t \rightarrow \infty$ , then all bounded network solutions synchronize and the synchronized solution converges to the limit set of the isolated system (i.e. the system where  $a_{k,j} = 0$  for every  $k, j$ ).  $\square$

*Remark 2:* The algebraic connectivity and the properties of the Laplacian matrices can be related to properties of the underlying interconnection graph associated to the compartmental coupling. The condition  $1^T L_k = 0$  required by Theorem 2 is equivalent to assuming that the underlying graphs are balanced (i.e. that for each vertex the sum of the weights of the edges entering in one vertex is equal to the sum of the weights of the edges exiting from the same vertex). Furthermore, since the resulting Laplacian matrices are doubly hyperdominant with zero excess, the condition implies that  $L_k + L_k^T$  are positive semidefinite and therefore the algebraic connectivity  $\lambda_k \geq 0$ . If furthermore we assume that the graph is connected, then the algebraic connectivity is guaranteed to be strictly positive (see e.g., [17]).

*Remark 3:* The results presented in the paper can be used to analyze and design nonlinear observers. To see this, consider two identical compartments interconnected through a unidirectional compartmental coupling (for convention going from compartment two to compartment one). The interconnection can involve one or more of the species. By interpreting the diffusive coupling terms as output injection, we can regard the first compartment as a nonlinear model and the second one as its state-observer. Thus Corollary 1 can be used to provide provable conditions for the observer error to converge to zero. The fact that our formulation allows for directed (non symmetric) graphs is here fundamental. In Section VII we will illustrate this idea with a specific example.

## VI. SPECIAL STRUCTURES AND SYNCHRONIZATION CONDITIONS

Our results are based on the condition that  $E_{\tilde{\gamma}}$  be diagonally stable, which is related to both the compartmental coupling (through the algebraic connectivity) and the species coupling (through the interconnection matrix  $\Sigma$ ). In this Section, we analyze a number of interconnection structures and provide conditions for the matrix  $E_{\tilde{\gamma}}$  to be diagonally stable. These conditions take the form of inequalities that link the algebraic connectivities of the compartmental coupling with the relaxed co-coercivity gains of the operators  $H_k$ .

*Cyclic Systems:* Stability of isolated cyclic systems is analyzed in [7]. Extending the work in [7], the output synchronization problem for cyclic systems was studied in [16], for the special case in which the interconnected systems are coupled *through the output of the first system only*. Our approach is suitable for more general coupling (the interconnection structure is depicted in Fig. 2). The interconnection matrix is

$$\Sigma_{\text{cyclic}} = \begin{bmatrix} 0 & 0 & \cdots & 0 & -1 \\ 1 & 0 & 0 & \ddots & 0 \\ 0 & 1 & 0 & \ddots & \vdots \\ \vdots & \ddots & \ddots & \ddots & 0 \\ 0 & \cdots & 0 & 1 & 0 \end{bmatrix}$$

and the dissipativity matrix is therefore

$$E_{\tilde{\gamma}} = \begin{bmatrix} -\tilde{\gamma}_1 & 0 & \cdots & 0 & -1 \\ 1 & -\tilde{\gamma}_2 & 0 & \ddots & 0 \\ 0 & 1 & -\tilde{\gamma}_3 & \ddots & \vdots \\ \vdots & \ddots & \ddots & \ddots & 0 \\ 0 & \cdots & 0 & 1 & -\tilde{\gamma}_N \end{bmatrix}.$$

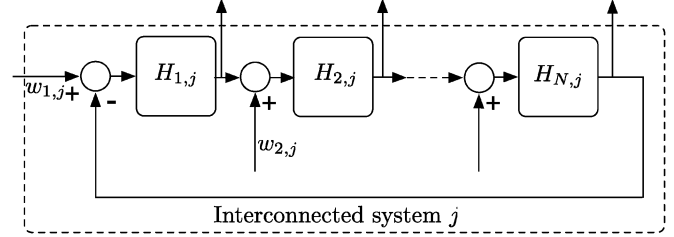

Fig. 2. Cyclic interconnection structure.

For this matrix to be diagonally stable the following secant condition must be satisfied [7]:

$$\frac{1}{\tilde{\gamma}_1} \frac{1}{\tilde{\gamma}_2} \cdots \frac{1}{\tilde{\gamma}_N} < \sec(\pi/N)^N.$$

Since  $\tilde{\gamma}_k = \gamma_k + \lambda_k > 0$ , the secant condition leads to:

$$\prod_{k=1}^N \frac{1}{\gamma_k + \lambda_k} < \sec(\pi/N)^N. \quad (36)$$

Our approach generalizes the result of [16] (note that  $\gamma_k$  correspond to  $1/\gamma_k$  in [16]) where the coupling among the systems is limited to the first system (i.e., when  $\lambda_j = 0$ ,  $j = 2, \dots, N$  in (36)). In fact, in this case (36) reduces to

$$\lambda_1 > \frac{\cos(\pi/N)^N}{\gamma_2 \cdots \gamma_N} - \gamma_1 \quad (37)$$

which is the expression provided in [16].

As an example, consider the case where each species in a compartment is directly connected to the respective species in each other compartment with the same weight  $q$ , i.e.  $a_{ij}^k = q$  for every  $i, j = 1, \dots, n$  and  $k = 1, \dots, N$ . This implies that the Laplacian matrices are

$$L_k = qn \left( I_n - \frac{1}{n} \mathbf{1}_n \mathbf{1}_n^T \right), \quad k = 1, 2, \dots, N$$

and that  $\lambda_k = qn$ ,  $k = 1, \dots, N$ . In this case, (36) specializes to

$$\prod_{k=1}^N \frac{1}{\gamma_k + qn} < \sec(\pi/N)^N$$

where, since  $\lambda_k + \gamma_k$  must be strictly positive, the condition  $q > -\gamma_k/n$ ,  $k = 1, 2, \dots, N$  must be satisfied. If we restrict the compartmental coupling to only the first species, (37) takes the simple form

$$qn > \frac{\cos(\pi/N)^N}{\gamma_2 \cdots \gamma_N} - \gamma_1.$$

*Branched Structures:* In [8] several interconnection structures have been analyzed and diagonal stability is proven for the associated dissipative matrices.

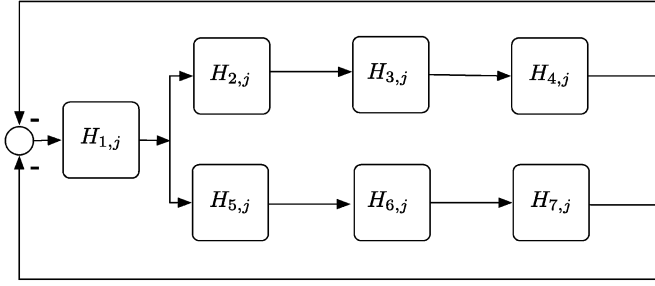

Fig. 3. Branched interconnection structure, for notational simplicity the inputs  $w_{jk}$  are not shown in the picture.

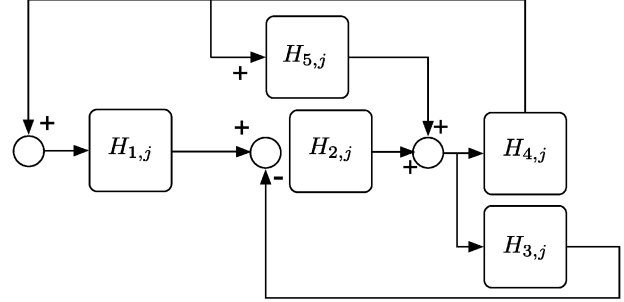

Fig. 4. Second type of branched interconnection structure. For notational simplicity the inputs  $w_{jk}$  are not shown in the picture.

- i) For the interconnection structure depicted in Fig. 3, the interconnection and dissipativity matrices are, respectively

$$\Sigma_{b1} = \begin{bmatrix} 0 & 0 & 0 & -1 & 0 & 0 & -1 \\ 1 & 0 & 0 & 0 & 0 & 0 & 0 \\ 0 & 1 & 0 & 0 & 0 & 0 & 0 \\ 0 & 0 & 1 & 0 & 0 & 0 & 0 \\ 1 & 0 & 0 & 0 & 0 & 0 & 0 \\ 0 & 0 & 0 & 0 & 1 & 0 & 0 \\ 0 & 0 & 0 & 0 & 0 & 1 & 0 \end{bmatrix},$$

$$E_{\tilde{\gamma}}^{b1} = \begin{bmatrix} -\tilde{\gamma}_1 & 0 & 0 & -1 & 0 & 0 & -1 \\ 1 & -\tilde{\gamma}_2 & 0 & 0 & 0 & 0 & 0 \\ 0 & 1 & -\tilde{\gamma}_3 & 0 & 0 & 0 & 0 \\ 0 & 0 & 1 & -\tilde{\gamma}_4 & 0 & 0 & 0 \\ 1 & 0 & 0 & 0 & -\tilde{\gamma}_5 & 0 & 0 \\ 0 & 0 & 0 & 0 & 1 & -\tilde{\gamma}_6 & 0 \\ 0 & 0 & 0 & 0 & 0 & 1 & -\tilde{\gamma}_7 \end{bmatrix}.$$

Lemma 2 in [20] shows that  $E_{\tilde{\gamma}}^{b1}$  is diagonally stable iff the condition

$$\frac{1}{\tilde{\gamma}_1 \tilde{\gamma}_2 \tilde{\gamma}_3 \tilde{\gamma}_4} + \frac{1}{\tilde{\gamma}_1 \tilde{\gamma}_5 \tilde{\gamma}_6 \tilde{\gamma}_7} < \sec(\pi/4)^4$$

holds. Since  $\tilde{\gamma}_k = \gamma_k + \lambda_k$ , the synchronization condition becomes

$$\frac{1}{\gamma_1 + \lambda_1} \left( \prod_{k=2}^4 \frac{1}{\gamma_k + \lambda_k} + \prod_{k=5}^7 \frac{1}{\gamma_k + \lambda_k} \right) < \sec(\pi/4)^4. \quad (38)$$

If we limit the coupling to the first species only, (38) reduces to

$$\lambda_1 > \frac{\gamma_2 \gamma_3 \gamma_4 + \gamma_5 \gamma_6 \gamma_7}{\gamma_2 \gamma_3 \gamma_4 \gamma_5 \gamma_6 \gamma_7} \cos(\pi/4)^4 - \gamma_1. \quad (39)$$

- ii) For the interconnection structure depicted in Fig. 4, the interconnection matrix is

$$\Sigma_{b2} = \begin{bmatrix} 0 & 0 & 0 & 1 & 0 \\ 1 & 0 & -1 & 0 & 0 \\ 0 & 1 & 0 & 0 & 1 \\ 0 & 1 & 0 & 0 & 1 \\ 0 & 0 & 0 & 1 & 0 \end{bmatrix}$$

and therefore the dissipativity matrix is

$$E_{\tilde{\gamma}}^{b2} = \begin{bmatrix} -\tilde{\gamma}_1 & 0 & 0 & 1 & 0 \\ 1 & -\tilde{\gamma}_2 & -1 & 0 & 0 \\ 0 & 1 & -\tilde{\gamma}_3 & 0 & 1 \\ 0 & 1 & 0 & -\tilde{\gamma}_4 & 1 \\ 0 & 0 & 0 & 1 & -\tilde{\gamma}_5 \end{bmatrix}.$$

The analysis in [8] gives the sufficient condition

$$\frac{1}{\tilde{\gamma}_1 \tilde{\gamma}_2 \tilde{\gamma}_4} + \frac{1}{\tilde{\gamma}_4 \tilde{\gamma}_5} < 1$$

which leads to

$$\frac{1}{\gamma_4 + \lambda_4} \left( \frac{1}{(\gamma_1 + \lambda_1)(\gamma_2 + \lambda_2)} + \frac{1}{\gamma_5 + \lambda_5} \right) < 1. \quad (40)$$

If we limit the coupling to the first species only, (40) reduces to

$$\lambda_1 > \frac{\gamma_5}{\gamma_2(\gamma_4 \gamma_5 - 1)} - \gamma_1. \quad (41)$$

## VII. CASE STUDIES

### A. Synchronization in Networks of Goodwin Oscillators

We illustrate the proposed theory via a genetic regulatory network example: the Goodwin oscillator. We consider a network of  $n$  identical Goodwin oscillators interconnected through a compartmental coupling described by Laplacian matrices  $L_k, k = 1, 2, \dots, N$ . The Goodwin model is an example of cyclic feedback systems described in Section VI where metabolites repress the enzymes which are essential for their own synthesis by inhibiting the transcription of the molecule DNA to messenger RNA (mRNA). The model for such a mechanism is schematically shown in Fig. 5(a) and can be described as the cyclic interconnection of 3 elementary subsystems plus a static nonlinearity [see Fig. 5(b)].

Each Goodwin oscillator can be modeled as a compartment made up of the following four cyclically interconnected subsystems (see [28] for more details)

$$S_{k,j} : \begin{cases} \dot{x}_{k,j} = -b_k x_{k,j} + c_k (v_{k,j} + w_{k,j}) \\ y_{k,j} = x_{k,j}, \end{cases}$$

$$S_{4,j} : \begin{cases} y_{4,j} = -\frac{1}{x_{3,j}^p + 1} \end{cases} \quad (42)$$

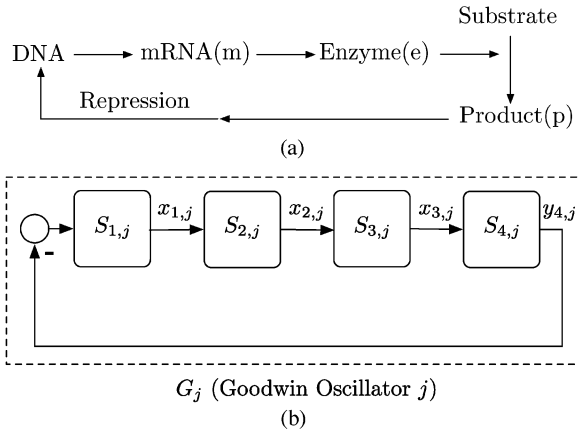

Fig. 5. (a) Biological interpretation for the Goodwin oscillator. The enzyme (e) combines with the substrate to produce a product (p) which represses the transcription of DNA to mRNA (m), the template for making the enzyme. (b) Input-output scheme representing the mathematical model (42) where  $u_{1,j} = -y_{4,j}$ ,  $u_{2,j} = y_{1,j}$ ,  $u_{3,j} = y_{2,j}$ .

$j = 1, 2, \dots, n$ ,  $k = 1, 2, 3$ , where  $b_k, c_k$  are positive coefficients,  $p > 1$  is the Hill coefficient (that measures the cooperativity of the end product repression) and  $w_{k,j}$  are external inputs. The interconnections are encompassed by the inputs

$$v_{k,j} = u_{k,j} + \sum_{z=1}^n a_{j,z}^k (x_{k,z} - x_{k,j}) \quad (43)$$

$k = 1, \dots, N$ ,  $j = 1, \dots, n$ , where  $u_{1,j} = -y_{4,j}$ ,  $u_{2,j} = y_{1,j}$ ,  $u_{3,j} = y_{2,j}$ , and give rise to the cyclic interconnection matrix

$$\Sigma_g = \begin{bmatrix} 0 & 0 & 0 & -1 \\ 1 & 0 & 0 & 0 \\ 0 & 1 & 0 & 0 \\ 0 & 0 & 1 & 0 \end{bmatrix}$$

while the second term in (43) represents the diffusion among the compartments.

From Section V, we observe that the linear sub-systems  $S_{k,j}$ ,  $k = 1, 2, 3$  can be associated to cocoercive operators with constants  $\gamma_k = b_k/c_k$ . The static nonlinearities  $S_{4,j}$  are monotone increasing functions that satisfy

$$\frac{d}{d\sigma} \left( -\frac{1}{\sigma^p + 1} \right) \leq \frac{1}{\gamma_4}$$

where

$$\gamma_4 = \frac{\left( p^{-1} \sqrt{\left( \frac{p-1}{p+1} \right)^p + 1} \right)^2 (p+1)}{p(p-1)}, \quad p > 1. \quad (44)$$

From Section V we know that the co-coercivity coefficient for the static nonlinearity is  $\gamma_4$ . Since all the blocks are associated to cocoercive operators, Assumption 1 in Theorem 1 is satisfied. The closed loop system is zero-state reachable since it can be fully actuated from the external inputs  $w_{k,j}$ . Furthermore it is proved in [16] that the positive orthant is an invariant set and

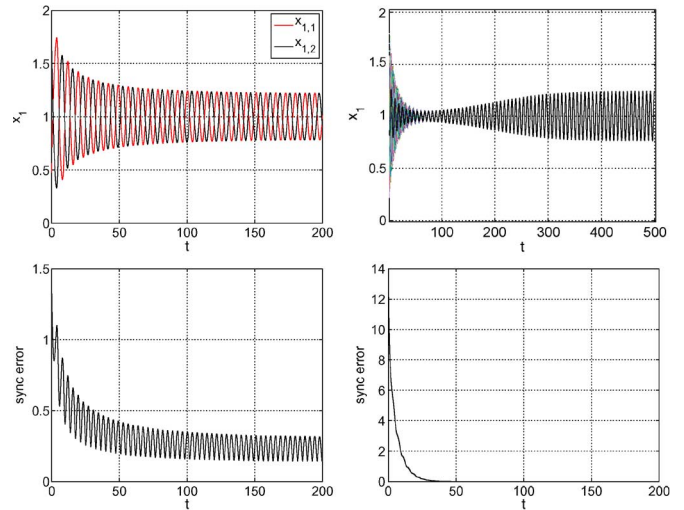

Fig. 6. Simulation results for a network of Goodwin oscillators where only the first species are coupled through a complete compartmental coupling  $G_c$  and where  $q = 3 \cdot 10^{-3}$ . On the left: two oscillators are not sufficient for synchronization. On the right: simulation results for 180 oscillators. As predicted by the synchronization condition the oscillators synchronize.

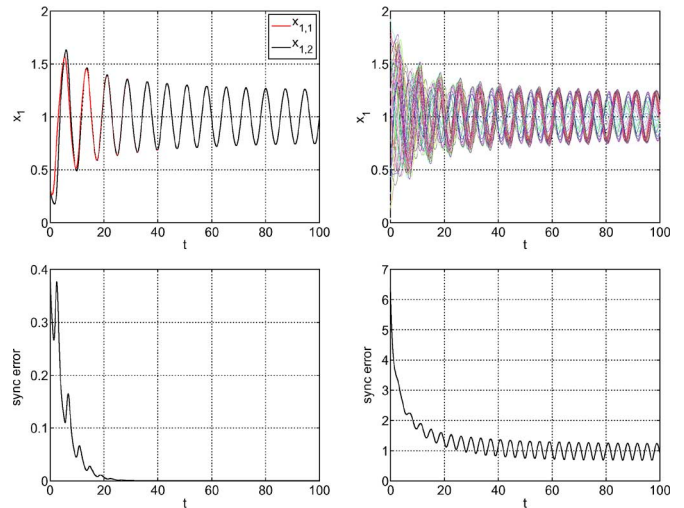

Fig. 7. Simulation results for a network of Goodwin oscillators where only the first species are coupled through a ring compartmental coupling  $G_r$  and where  $q = 0.15$ . On the left: as predicted by the synchronization condition four oscillators are sufficient for the network to synchronize. On the right: the number of cells is increased up to 45 and synchronization is not observed.



that the solutions of the closed loop system are bounded. The secant condition for cyclic systems (36) specifies to

$$(\gamma_1 + \lambda_1)(\gamma_2 + \lambda_2)(\gamma_3 + \lambda_3) > c, \quad c = \frac{1}{\gamma_4 \sec(\pi/4)^4}. \quad (45)$$

Therefore, if (45) holds, then all the conditions of Corollary 1 are satisfied and we conclude that the concentrations of the species in different compartments synchronize when  $w_{k,j} = 0$ ,  $k = 1, 2, 3$ ,  $j = 1, 2, \dots, n$ .

When the compartments are isolated each of them has a unique equilibrium. By choosing the parameters  $b_k = c_k = 1$ ,  $k = 2, 3$  and  $b_1 = 0.5$ ,  $c_1 = 1$  it can be easily proved that the equilibria are asymptotically stable when  $p < 16$ . When  $p = 16$  the steady state undergoes Hopf bifurcation and for  $p = 17$  a

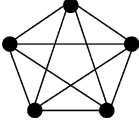
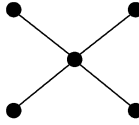
TABLE I  
SUFFICIENT CONDITIONS, OBTAINED FROM (47), TO ACHIEVE SYNCHRONIZATION FOR DIFFERENT DIFFUSIVE GRAPH TOPOLOGIES. FOR EACH GRAPH DEPICTED IN THE FIRST COLUMN, WE CONSIDER TWO CASES: (1) ONLY THE FIRST SPECIES IN EACH COMPARTMENT ARE ALLOWED TO “DIFFUSE”, AND (2) BOTH THE FIRST AND SECOND SPECIES “DIFFUSE”

Graph	$\lambda_1$	$\lambda_2$	Synchronization condition
 $G_c$ (Complete)	$nq$	0	$n > \frac{c - 0.5}{q}$
	$nq$	$nq$	$n > \frac{-3 + \sqrt{9 + 8c}}{4q}$
 $G_s$ (Star)	$q$	0	$q > c - 0.5$
	$q$	$q$	$q > \frac{-3 + \sqrt{9 + 8c}}{4}$
 $G_r$ (Ring)	$4q \sin^2(\frac{\pi}{n})$	0	$q > \frac{c - 0.5}{4}$ $n < \frac{\pi}{\arcsin(\sqrt{\frac{c-0.5}{4q}})}$
	$4q \sin^2(\frac{\pi}{n})$	$4q \sin^2(\frac{\pi}{n})$	$q > \frac{-3 + \sqrt{9 + 8c}}{16}$ $n < \frac{\pi}{\arcsin(\sqrt{\frac{-3 + \sqrt{9 + 8c}}{16q}})}$
 $G_l$ (Line)	$2q[1 - \cos(\frac{\pi}{n})]$	0	$q > \frac{c - 0.5}{2}$ $n < \frac{\pi}{\arccos(\frac{c-0.5}{2q} + 1)}$
	$2q[1 - \cos(\frac{\pi}{n})]$	$2q[1 - \cos(\frac{\pi}{n})]$	$q > \frac{\sqrt{9 + 8c} - 3}{8}$ $n < \frac{\pi}{\arccos(\frac{3 - \sqrt{9 + 8c}}{8q} + 1)}$

stable limit cycle arises. With this choice, the cocoercive gains are  $\gamma_2 = \gamma_3 = 1, \gamma_1 = 0.5$ . By substituting  $p = 17$  in (44) we obtain  $\gamma_4 \cong 0.23$  and the secant condition (45) becomes

$$(0.5 + \lambda_1)(1 + \lambda_2)(1 + \lambda_3) > c, \quad c := \frac{1}{\gamma_4 \sec(\pi/4)^4} \cong 1.06. \tag{46}$$

Condition (46) relates the compartmental coupling to the synchronization property of the compartments through the algebraic connectivities  $\lambda_k, k = 1, 2, 3$ .

For simplicity, we assume that those edges that exist all have the same weight  $q$  (which can be interpreted as diffusion coefficients), i.e.  $a_{i,j}^k \in \{0, q\}$  for every  $k = 1, 2, 3, i, j = 1, 2, \dots, n$ . Consider for example the case in which only the first and the second species diffuse. Then condition (46) reduces to

$$(0.5 + \lambda_1)(1 + \lambda_2) > c. \tag{47}$$

By substituting the expression for the algebraic connectivity (for different graph topologies) in the second order inequality

(47) we can find conditions on the number of cells and the diffusion coefficients such that synchronization is guaranteed. In Table I we list these conditions for a number of relevant graph topologies.

The resulting relations admit interesting biological interpretations. Let us think of each compartment as a biochemical network inside each cell in a population or “colony” of  $n$  identical cells.

Consider the complete graph denoted as  $G_c$  in Table I. Now pick a diffusivity coefficient  $q$  for which our “synchronization condition” estimates fail to hold, and suppose that the overall network does not synchronize. From Table I, we observe that a sufficient increase in the total number of cells in the colony will result in synchronization between all the cells. Thus, we may view the number of cells as an order parameter (or “synchronization bifurcation” parameter). Numerical simulations substantiate this claim, as shown in Fig. 6.

As another example, consider the star graph  $G_s$ . Analyzing the conditions in Table I, we see that, for this type of graph, the

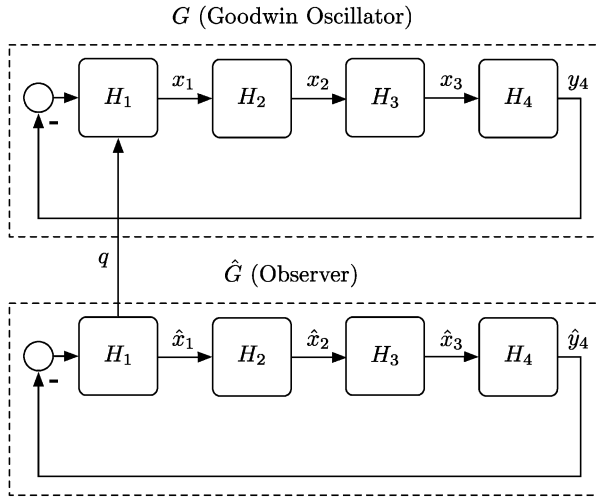

Fig. 8. System-observer interpretation for two Goodwin oscillators unidirectionally coupled.

number of cells does not play a role in the conditions for synchronization. Instead, it is only required now that  $q$  be beyond a given threshold.

The ring graph  $G_r$  and the line graph  $G_l$  lead to a quite different qualitative picture. First, note that we obtain two separate conditions for  $q$  and  $n$ . If  $q$  is sufficiently large (e.g., in the case of first and second species coupled,  $q > 0.074$  for  $G_r$  and  $q > 0.148$  for  $G_l$ ), then we have an upper bound on the number of cells, instead of a lower bound. Thus, for either line or ring topologies, in which the graph diameter increases with the number of cells, we see that a large number of cells,  $n$ , leads to more restrictive conditions for synchronization. In Fig. 7, this phenomenon is illustrated through simulations. Indeed, numerous bounds have been derived in the literature [29], [30] which show that, as the diameter is increased to infinity, the algebraic connectivity of a graph tends to zero.

### B. Synchronization Conditions and Observer Design

To illustrate the idea introduced in Remark 3, we consider two Goodwin oscillators and a directed link coupling the first species. This special interconnection structure gives rise the following system-observer dynamics:

$$G : \begin{cases} \dot{x}_1 = -0.5x_1 - y_4 \\ \dot{x}_2 = -0.5x_2 + 0.5x_1 \\ \dot{x}_3 = -0.5x_3 + 0.5x_2 \\ y_4 = -\frac{1}{x_3^p + 1} \end{cases}$$

$$\hat{G} : \begin{cases} \dot{\hat{x}}_1 = -0.5\hat{x}_1 - \hat{y}_4 + q(x_1 - \hat{x}_1) \\ \dot{\hat{x}}_2 = -0.5\hat{x}_2 + 0.5\hat{x}_1 \\ \dot{\hat{x}}_3 = -0.5\hat{x}_3 + 0.5\hat{x}_2 \\ \hat{y}_4 = -\frac{1}{\hat{x}_3^p + 1}. \end{cases}$$

The term  $q(x_1 - \hat{x}_1)$  (where  $q$  is the weight of the link), that was interpreted as diffusion of the first species concentrations, is now the output injection to the observer  $\hat{G}$  (see Fig. 8). Then the synchronization condition (47) reduces to

$$0.5 + 2q > c, \quad c \cong 1.06$$

and can be interpreted as a sufficient condition for the observer error to converge to zero. We conclude that if

$$q > \frac{c - 0.5}{2}$$

then the errors  $x_k - \hat{x}_k \rightarrow 0$  as  $t \rightarrow \infty$ ,  $k = 1, 2, 3$ .

## VIII. CONCLUSION

Synchronization properties for networks of nonlinear systems have been investigated combining the input-output properties of the subsystems with the information about the network structure. The proposed model is motivated by cellular networks where signaling occurs both internally, through interactions of species, and externally, through intercellular signaling. Results for state-space models as well as biochemical applications have been derived as corollaries of the main result.

## REFERENCES

- [1] J. K. Hale, "Diffusive coupling, dissipation, and synchronization," *J. Dyn. Differential Equations*, vol. 9, no. 1, pp. 1–52, Jan. 1996.
- [2] Q. Pham and J. Slotine, "Stable concurrent synchronization in dynamic system networks," *Neural Networks*, vol. 20, no. 1, pp. 62–77, Feb. 2007.
- [3] G. Stan and R. Sepulchre, "Analysis of interconnected oscillators by dissipativity theory," *IEEE Trans. Autom. Control*, vol. 52, no. 2, pp. 256–270, Feb. 2007.
- [4] A. Pogromsky, "Passivity based design of synchronizing systems," *Int. J. Bifurcation Chaos*, vol. 8, no. 2, pp. 295–319, 1998.
- [5] L. Scardovi, A. Sarlette, and R. Sepulchre, "Synchronization and balancing on the  $N$ -torus," *Syst. Control Lett.*, vol. 56, no. 5, pp. 335–341, May 2007.
- [6] E. Sontag, "Passivity gains and the "secant condition" for stability," *Syst. Control Lett.*, vol. 55, no. 3, pp. 177–183, 2006.
- [7] M. Arcak and E. D. Sontag, "Diagonal stability of a class of cyclic systems and its connection with the secant criterion," *Automatica*, vol. 42, no. 9, pp. 1531–1537, Sep. 2006.
- [8] M. Arcak and E. D. Sontag, "A passivity-based stability criterion for a class of biochemical reaction networks," *Math. Biosci. Eng.: MBE*, vol. 5, no. 1, pp. 1–19, Jan. 2008.
- [9] R. Sepulchre, M. Janković, and P. Kokotović, *Constructive Nonlinear Control*. New York: Springer, 1997.
- [10] A. van der Schaft, *L2-Gain and Passivity Techniques in Nonlinear Control*. New York: Springer, 2000.
- [11] M. Vidyasagar, *Input-Output Analysis of Large Scale Interconnected Systems*. Berlin, Germany: Springer Verlag, 1981.
- [12] M. Sundareshan and M. Vidyasagar, " $l^2$ -stability of large-scale dynamical systems: Criteria via positive operator theory," *IEEE Trans. Autom. Control*, vol. AC-22, no. 3, pp. 396–400, Jun. 1977.
- [13] P. Moylan and D. Hill, "Stability criteria for large-scale systems," *IEEE Trans. Autom. Control*, vol. AC-23, no. 2, pp. 143–149, Jan. 1978.
- [14] J. Tyson and H. Othmer, "The dynamics of feedback control circuits in biochemical pathways," in *Progress in Theoretical Biology*, R. Rosen and F. Snell, Eds. New York: Academic Press, Jan. 1978, vol. 5, pp. 1–62.
- [15] C. Thron, "The secant condition for instability in biochemical feedback control—Parts I and II," *Bull. Math. Biol.*, vol. 53, pp. 383–424, May 1991.
- [16] G. B. Stan, A. Hamadeh, R. Sepulchre, and J. Goncalves, "Output synchronization in networks of cyclic biochemical oscillators," in *Proc. Amer. Control Conf.*, 2007, pp. 3973–3978.
- [17] C. W. Wu, "Algebraic connectivity of directed graphs," *Lin. Multilin. Algebra*, vol. 53, no. 3, pp. 203–223, Jun. 2005.
- [18] J. C. Willems, *The Analysis of Feedback Systems*. Cambridge, MA: MIT Press, 1971.
- [19] R. U. Verma, "Sensitivity analysis for relaxed cocoercive nonlinear quasivariational inclusions," *J. Appl. Math. Stochastic Anal.*, vol. 2006, pp. 1–9, 2006.
- [20] E. Sontag and M. Arcak, "Passivity-based stability of interconnection structures," in *Lecture Notes in Control and Information Sciences*. New York: Springer, 2007, pp. 195–204.
- [21] W. Desch, H. Logemann, E. Ryan, and E. Sontag, "Meagre functions and asymptotic behaviour of dynamical systems," *Nonlin. Anal.*, vol. 44, no. 8, pp. 1087–1109, 2001.

- [22] P. Bohl, "Über differentialgleichungen," *J. Reine Angew. Math.*, vol. 144, pp. 284–313, 1913.
- [23] J. L. Dalecki and M. G. Krein, "Stability of solutions of differential equations in banach spaces," in *Transl. Math. Monographs*. Providence, RI: American Mathematical Society, 1974, vol. 43.
- [24] A. Pavlov, A. Pogromsky, N. van de Wouw, and H. Nijmeijer, "Convergent dynamics, a tribute to Boris Pavlovich Demidovich," *Syst. Control Lett.*, vol. 52, pp. 257–261, Jul. 2004.
- [25] X. Liu and T. Chen, Network Synchronization With an Adaptive Coupling Strength arXiv:math/0610580, 2006.
- [26] P. De Lellis, M. di Bernardo, and F. Garofalo, "Synchronization of complex networks through local adaptive coupling," *Chaos*, vol. 18, p. 037110, 2008.
- [27] J. Lu and D. W. Ho, "Local and global synchronization in general complex dynamical networks with delay coupling," *Chaos, Solitons Fractals*, vol. 37, pp. 1497–1510, 2008.
- [28] C. Fall, E. S. Marland, J. Wagner, and J. J. Tyson, *Computational Cell Biology*. New York: Springer, 2005.
- [29] N. Alon and V. Milman, " $\lambda_1$ , Isoperimetric inequalities for graphs and superconcentrators," *J. Combinatorial Theory*, vol. B 38, pp. 73–88, 1985.
- [30] F. Chung, V. Faber, and T. Manteuffel, "An upper bound on the diameter of a graph from eigenvalues associated with its Laplacian," *SIAM J. Discrete Math.*, vol. 7, no. 3, pp. 443–457, 1994.



**Luca Scardovi** (M'06) received the Laurea degree and the Ph.D. degree in electronic and computer engineering from the University of Genoa, Genoa, Italy, in 2001 and 2005, respectively.

In 2005, he was Adjunct Professor at the University of Salento, Lecce, Italy. He held research associate positions at the Department of Electrical Engineering and Computer Science, University of Liège, Belgium, 2005–2007, and at the Department of Mechanical and Aerospace Engineering, Princeton University, Princeton, NJ, 2007–2009. He is currently an

Assistant Professor in the Department of Electrical Engineering and Information Technology, Technische Universität München (TUM), Munich, Germany. His research interests focus on dynamical systems with special emphasis in the analysis and control of complex networked systems.



**Murat Arcaç** (SM'05) received the B.S. degree in electrical and electronics engineering from the Bogazici University, Istanbul, in 1996, and the M.S. and Ph.D. degrees in electrical and computer engineering from the University of California, Santa Barbara, in 1997 and 2000, respectively.

He was an Assistant Professor (2001–2006) and an Associate Professor (2006–2008) at the Rensselaer Polytechnic Institute, Troy, NY. He is now an Associate Professor in the Electrical Engineering and Computer Sciences Department, University of California, Berkeley.

and an associate editor for the IFAC journal Automatica. His research is in nonlinear control theory and its applications, with particular interest in distributed control for networks of dynamic systems.

Dr. Arcaç received a CAREER Award from the National Science Foundation in 2003, the Donald P. Eckman Award from the American Automatic Control Council in 2006, and the SIAG/CST Prize from the Society for Industrial and Applied Mathematics in 2007. He is a member of SIAM.

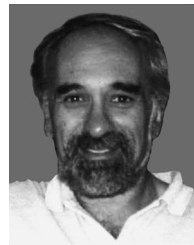

**Eduardo D. Sontag** (F'93) received the Licenciado degree in mathematics from the University of Buenos Aires, Buenos Aires, Argentina, in 1972, and the Ph.D. degree in mathematics from the Center for Mathematical Systems Theory, University of Florida, Gainesville, in 1976.

Since 1977, he has been with the Department of Mathematics, Rutgers, The State University of New Jersey, where he is currently Professor II of Mathematics and a member of the Advisory Committee for BioMapS Institute for Quantitative Biology. He is

also a Member of the Graduate Faculties of the Department of Computer Science and of the Department of Electrical and Computer Engineering, the Director of the Rutgers Center for Systems and Control, and a member of the Cancer Institute of New Jersey. He has authored over 400 journal and conference papers and book chapters, as well as the three books. His major current research interests lie in several areas of systems molecular biology and control theory.

Dr. Sontag received the Reid Prize in Mathematics in 2001, the 2002 Hendrik W. Bode Lecture Prize from the IEEE, the 2002 Board of Trustees Award for Excellence in Research from Rutgers, and the 2005 Teacher/Scholar Award from Rutgers. He is a Fellow of the Society for Industrial and Applied Mathematics (SIAM).